

Flare™

2KSDI CAMERAS



Video cameras with Global Shutter CMOS Sensors

APPLICATIONS

Aircraft and Vehicle Recording

Security and Surveillance

Medical Imaging

Specialty Video Production



FEATURES INCLUDE:

- Compact One-Piece Rugged Design
- 2/3" Low-Noise Global Shutter Sensor
- Multiple Lens Mount Options (C, Active EF)
- 3G/HD-SDI Output Formats
- 10-bit 4:2:2, 4:4:4, or RAW Output
- Synchronize Multiple Cameras via Tri-Level Sync
- Adjustable Color Matrix, Saturation and Gamma
- Advanced Auto Exposure Control

SPECIFICATIONS

Camera Model	Flare 2KSDI
Output Modes	2K, 1080p, 1080i, 720p, up to 60 fps
Optical Format	Approx. 2/3" (2K: 12.7mm diagonal, 1080p/i: 12.1mm diagonal, 720p: 8.1mm diagonal)
Sensor Type	CMOS w. global electronic shutter
Sensor Options	Color (Bayer) or Near IR enhanced monochrome
Dynamic Range	60 dB (10 stops)
Output Interface	Single-Link 3G/HD-SDI (two outputs: optional OSD overlay on SDI1, clean output on SDI2)
Output Format	10-bit 4:2:2(Y'Cb'Cr'), 4:4:4 (RGB) or RAW (Bayer)
Exposure Control	Automatic (AEC) or manually adjustable
Luma Control	Gamma, master pedestal, white clipping offset with adjustable knee function
Color Control	Color matrix, RGB offsets, saturation adjustment, Preset/Auto/Tracking White Balance
Synchronization	Tri-level sync input (BNC)
Camera Configuration	RS-485, use handheld remote for OSD or use PC software, cables up to 1000 ft
Mechanical/Electrical	
Dimensions	63.5 mm x 63.5 mm x 44.1 mm
Lens Mount	C-mount, Active EF-mount
Camera Mounting Points	4x 1/4"-20, 8x #8-32
Weight	310g
Power Requirements	4.5W, 10-19V DC via Hirose 12-pin
Operating Temperature	0°C to 50°C, 20-85% humidity (non-condensing)
Storage Temperature	-40°C to 85°C, 10-90% humidity (non-condensing)

OUTPUT MODES

Single-Link HD-SDI :

720p 10-bit 4:2:2/RAW:	50, 59.94, 60
1080i 10-bit 4:2:2/RAW:	50, 59.94, 60
1080p 10-bit 4:2:2/RAW:	23.98, 24, 25, 29.97, 30
2K 10-bit 4:2:2/RAW:	23.98, 24, 25, 29.97, 30

Single-Link 3G-SDI:

1080p 10-bit 4:2:2/RAW:	50, 59.94, 60
1080p 10-bit 4:4:4:	23.98, 24, 25, 29.97, 30
2K 10-bit 4:2:2/RAW:	47.95, 48, 50, 59.94, 60
2K 10-bit 4:4:4:	23.98, 24, 25, 29.97, 30

ORDERING

Part Number	Sensor Type
2KSDI	Color
2KMDSI	Monochrome
2KNSDI	Near IR Enhanced Monochrome

For 2KSDI (color) complete kit including accessories, use P/N 2KSDIKIT[xx] (NA/EU/UK). Includes 2KSDI, FLARESDIRMT, ACPWRTAP[xx], CABFLAREBATT, and CABUSB4852M

MECHANICAL DIAGRAMS

Front

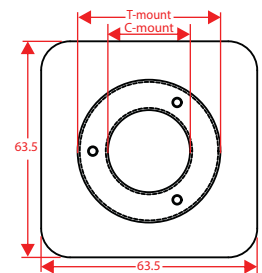

Top

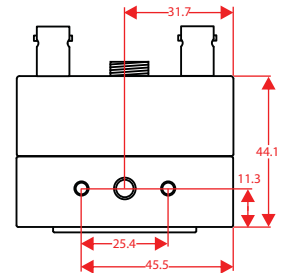

Rear

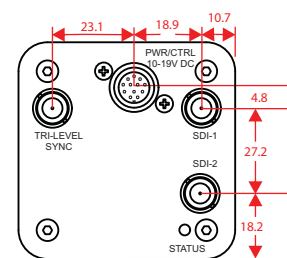

ACCESSORIES

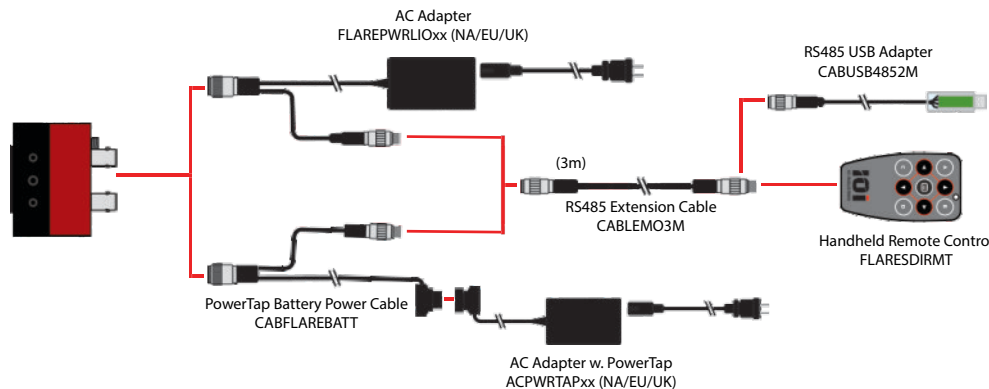

Visit us at: www.ioindustries.com
 15940 Robin's Hill Road
 London, Ontario, Canada, N5V 0A4
 Tel: +1 519 663 9570
 Email: sales@ioindustries.com

LET'S STAY CONNECTED!



@IOINDUSTRIES



@IOINDUSTRIES



@IO-INDUSTRIES

Copyright © 2016 IO Industries Inc. Flare is a trademark of IO Industries. All other trademarks are the property of their respective owners.

Datasheet Rev. 3.0 (06/10/2016)
 Specifications subject to change without notice